



ETA-Danmark A/S
Göteborg Plads 1
DK-2150 Nordhavn
Tel. +45 72 24 59 00
Fax +45 72 24 59 04
Internet www.etadanmark.dk

Authorised and notified according
to Article 29 of the Regulation (EU)
No 305/2011 of the European
Parliament and of the Council of 9
March 2011

MEMBER OF EOTA



European Technical Assessment ETA-23/0254 of 2023/03/28

I General Part

Technical Assessment Body issuing the ETA and designated according to Article 29 of the Regulation (EU) No 305/2011: ETA-Danmark A/S

Trade name of the construction product:

AT-HP / AT-HP PLUS / S&P ResAC-19

Product family to which the above construction product belongs:

Bonded injection type anchor for use in masonry:
sizes M6 to M12

Manufacturer:

Simpson Strong-Tie®
Rue du Camp
Z.A.C. des Quatre Chemins
F-85400 Sainte Gemme La Plaine
Tel. +33 2 51 28 44 00
Fax +33 2 51 28 44 01
Internet www.simpson.fr

Manufacturing plant:

Simpson Strong-Tie®
Manufacturing Facilities

This European Technical Assessment contains:

21 pages including 15 annexes which form an
integral part of the document

This European Technical Assessment is issued in accordance with Regulation (EU) No 305/2011, on the basis of:

EAD 330076-00-0604, Metal injection anchors for
use in masonry

This version replaces:

Translations of this European Technical Assessment in other languages shall fully correspond to the original issued document and should be identified as such.

Communication of this European Technical Assessment, including transmission by electronic means, shall be in full (except the confidential Annexes referred to above). However, partial reproduction may be made, with the written consent of the issuing Technical Assessment Body. Any partial reproduction has to be identified as such.

II SPECIFIC PART OF THE EUROPEAN TECHNICAL ASSESSMENT

1 Technical description of product and intended use

Technical description of the product

The AT-HP / AT-HP PLUS / S&P ResAC-19 – which are different trade names for the same product – is a bonded anchor (injection type) for use in masonry consisting of a cartridge with Simpson Strong-Tie injection mortar a perforated nylon sleeve, and an anchor rod with hexagon nut and washer in the range of M6, M8, M10 and M12.

The product specification is given in annex A.

The steel element is placed into a drilled hole filled with injection mortar and is anchored via the bond between metal part, injection mortar and masonry.

The characteristic material values, dimensions and tolerances of the anchors not indicated in Annexes shall correspond to the respective values laid down in the technical documentation¹ of this European Technical Assessment.

2 Specification of the intended use in accordance with the applicable EAD

The performances given in Section 3 are only valid if the anchor is used in compliance with the specifications and conditions given in Annex B.

The provisions made in this European Technical Assessment are based on an assumed intended working life of the anchor of 50 years.

The indications given on the working life cannot be interpreted as a guarantee given by the producer or Assessment Body, but are to be regarded only as a means for choosing the right products in relation to the expected economically reasonable working life of the works.

¹ The technical documentation of this European Technical Assessment is deposited at ETA-Danmark and, as far as relevant for the tasks of the Notified bodies involved in the attestation of conformity procedure, is handed over to the notified bodies.

3 Performance of the product and references to the methods used for its assessment

3.1 Characteristics of product

Mechanical resistance and stability (BWR 1):

The essential characteristics are detailed in the Annex C.

Safety in case of fire (BWR 2):

The essential characteristics are detailed in the Annex C.

Hygiene, health and the environment (BWR3):

No performance assessed

Safety in use (BWR4):

For basic requirement Safety in use the same criteria are valid for Basic Requirement Mechanical resistance and stability (BWR1).

Other Basic Requirements are not relevant.

3.2 Methods of assessment

The assessment of fitness of the anchor for the intended use in relation to the requirements for mechanical resistance and stability and safety in use in the sense of the Basic Requirements 1 and 4 has been made in accordance with EAD 330076-00-0604, Metal injection anchors for use in masonry.

4 Assessment and verification of constancy of performance (AVCP)

4.1 AVCP system

According to the decision 1997/177/EC of the European Commission, the system(s) of assessment and verification of constancy of performance (see Annex V to Regulation (EU) No 305/2011) is 1.

5 Technical details necessary for the implementation of the AVCP system, as foreseen in the applicable EAD

Technical details necessary for the implementation of the AVCP system are laid down in the control plan deposited at ETA-Danmark prior to CE marking.

Issued in Copenhagen on 2023-03-28by

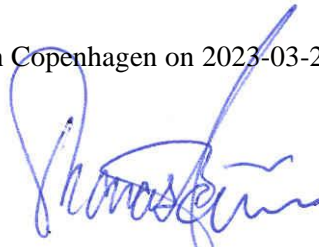

Thomas Bruun
Managing Director, ETA-Danmark

Cartridge: AT-HP / AT-HP PLUS / S&P ResAC-19

- A) Foil Bag Cartridge 165ml, 300ml.**
- B) Coaxial Cartridge 380ml / 400 ml / 410 ml / 420ml**
- C) Side by Side Cartridge 345ml, 825ml**

Cartridge Print : AT-HP / AT-HP PLUS / S&P ResAC-19
 Including - Installation procedure, Production Batch code, Expiry Date, Storage conditions, Health & Safety warning, Gel & Cure time according to temperatures.

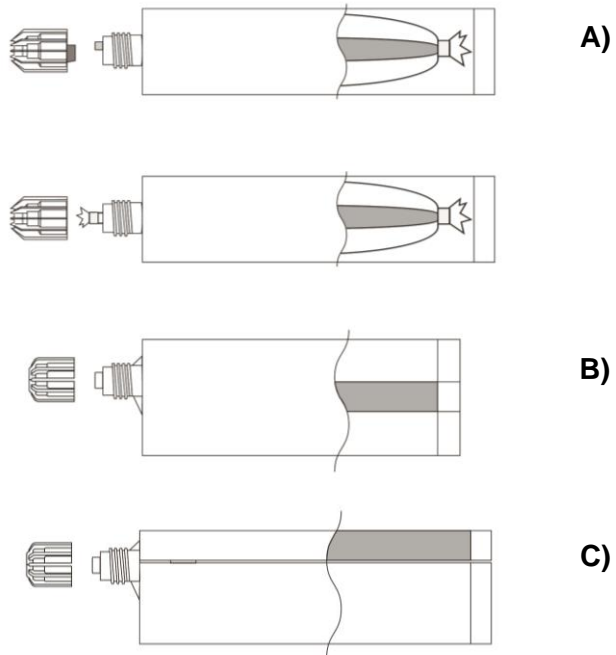

Marking:

AT-HP / AT-HP PLUS / S&P ResAC-19
 Batch code, either expiry date or manufacturing date with shelf life

Mixer with hanger

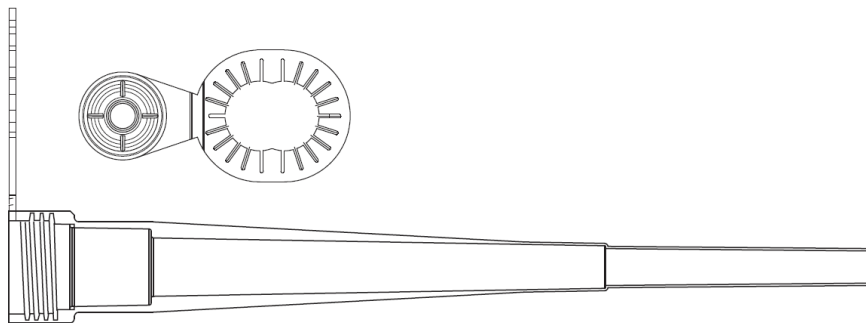

Mixer

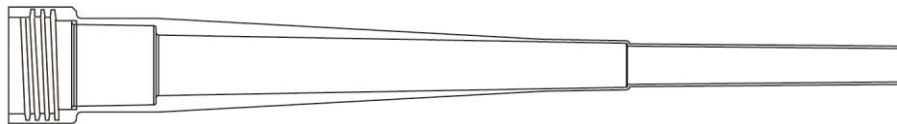

AT-HP / AT-HP PLUS / S&P ResAC-19

Product and intended use

Annex A1
 of European
 Technical Assessment
 ETA-23/0254

Anchor application in solid masonry (brick n°1 according to Annex B9)

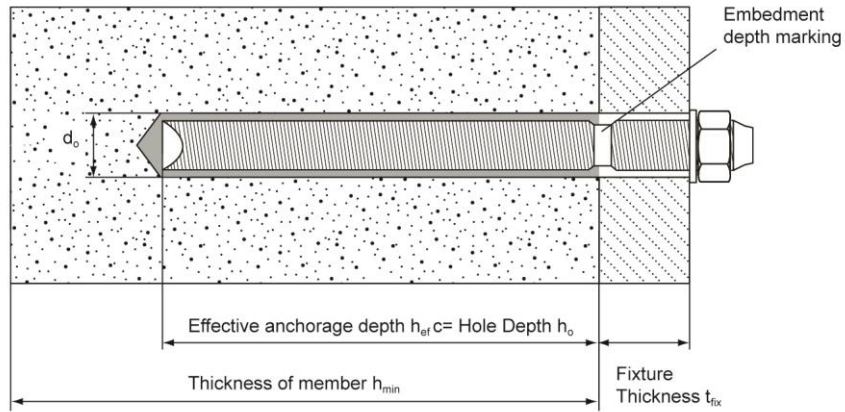

Anchor application in hollow/perforated masonry with nylon sleeve (brick n°2 according to Annex B9)

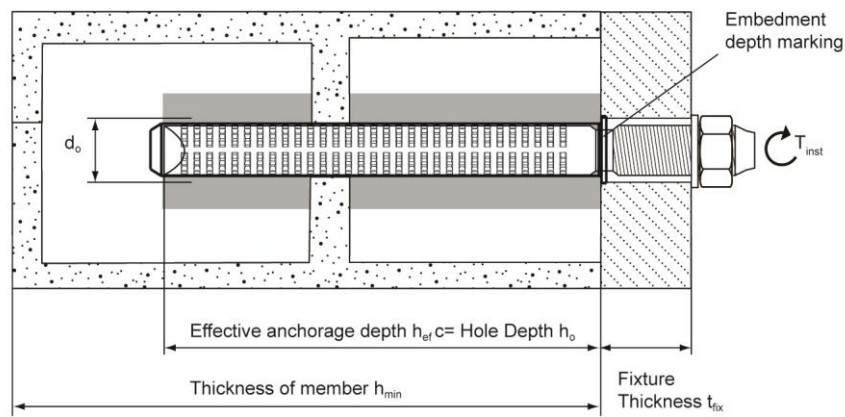

AT-HP / AT-HP PLUS / S&P ResAC-19

Product and intended use (2)

Annex A2

of European
Technical Assessment
ETA-23/0254

Injection Mortar : AT-HP / AT-HP PLUS / S&P ResAC-19 – Resin System

Plastic sleeve for hollow/perforated masonry: nominal dimensions and material

Resin sleeves are the effective way to create a fixing where there is a hollow void, such as for perforated bricks and blocks, or a more porous material for example blockwork. Resin is injected to fill the volume of the sleeve, and then forced through the fine perforations once the metal fixing rod is inserted. This distributes the resin material into the fixing cavity, forming a solid joint between the resin, the sleeve and the fixing.

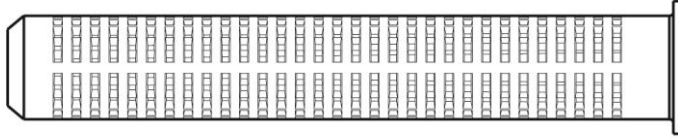

65565 - Nylon Perforated Sleeve – 16 x 85

Nominal Diameter 16mm

Nominal Length 85mm

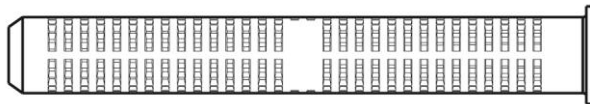

65580 - Nylon Perforated Sleeve – 12 x 80

Nominal Diameter 12mm

Nominal Length 80mm

Table A1: Minimum curing time

Minimum base material temperature C°	Gel time (working time) In dry/wet concrete	Curing time in dry concrete	Curing time in wet concrete
0°C ≤ T _{base material} < 10°C	20 min	90 min	180 min
10°C ≤ T _{base material} < 20°C	9 min	60 min	120 min
20°C ≤ T _{base material} < 30°C	5 min	30 min	60 min
30°C ≤ T _{base material} ≤ 40°C	3 min	20 min	40 min

The temperature of the bond material must be ≥ 20°C

AT-HP / AT-HP PLUS / S&P ResAC-19

Plastic sleeve and curing times

Annex A3
of European
Technical Assessment
ETA-23/0254

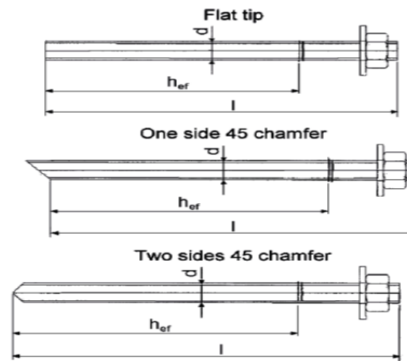
**Table A2: Threaded rod dimensions**

Anchor size			M6	M8	M10	M12
Diameter of anchor rod	d	[mm] =	6	8	10	12
Size of sleeve	d _{nom} x l _s	[mm] =	12 x 80		16 x 85	
Nominal anchorage depth	h _{ef}	[mm] =	80		85	
Maximum diameter hole in fixture	d _{fix}	[mm] ≤	7	9	12	14
Installation torque moment	T _{inst}	[Nm] =	2	2	2	2
Depth of drilled hole to deepest point	h ₁	[mm] =	h _{ef} + 5 mm			

Table A3: Threaded rods materials

Designation	Material
Threaded rods made of zinc coated steel	
Threaded rod M6 – M12	Strength class 4.6, 4.8, 5.6, 5.8, 8.8, 10.9 and 12.9 EN ISO 898-1 Steel galvanized ≥ 5µm EN ISO 4042 Hot dipped galvanized ≥ 45µm EN ISO 10684
Washer ISO 7089	Steel galvanized EN ISO 4042; hot dipped galvanized EN ISO 10684
Nut EN ISO 4032	Strength class 8 EN ISO 898-2 Steel galvanized ≥ 5µm EN ISO 4042 Hot dipped galvanized ≥ 45µm EN ISO 10684
Threaded rods made of stainless steel	
Threaded rod M6 – M12	Strength class A2 or A4 – 50, A2 or A4-70 and A4-80 EN ISO 3506-1;
Washer ISO 7089	Strength class A4-70 and A4-80 EN ISO 3506-1;
Nut EN ISO 4032	Strength class A4-70 and A4-80 EN ISO 3506-1;
Threaded rods made of high corrosion resistant steel	
Threaded rod M6 – M12	Strength class 70 or 80. High corrosion resistant steel 1.4529, 1.4565 EN 10088
Washer ISO 7089	High corrosion resistant steel 1.4529, 1.4565 EN 10088
Nut EN ISO 4032	Strength class 70 or 80 EN ISO 3506-2; High corrosion resistant steel 1.4529, 1.4565 EN 10088

Commercial standard threaded rods with:

- material and mechanical properties according to Table A3;
- confirmation of material and mechanical properties by inspection certificate 3.1 according to EN-10204:2004;
- marking of the threaded rod with the embedment depth.

AT-HP / AT-HP PLUS / S&P ResAC-19

Materials

Annex A4

of European
Technical Assessment
ETA-23/0254

Use:

The anchors are intended to be used for anchorages for which requirements for mechanical resistance and stability and safety in use in the sense of the Basic Requirements 1 and 4 of Regulation 305/2011 (EU) shall be fulfilled and failure of anchorages made with these products would compromise the stability of the works, cause risk to human life and/or lead to considerable economic consequences.

Anchors subject to:

- Static and quasi-static loads: M6 to M12

Base materials:

- Solid masonry (use category b) or hollow or perforated masonry (use category c) according to Annex B9. The mortar strength class of the masonry has to be M 2,5 according to EN 998-2:2010 at minimum

Temperature range:

The anchors may be used in the following temperature range:

- (a) -40°C to +40°C (max. short term temperature +40°C and max. long term temperature +24°C)

Use conditions (Environmental conditions):

Threaded rods:

- a) Carbon galvanized steel class 4.6, 4.8, 5.6, 5.8, 8.8, 10.9 or 12.9 according to EN ISO 898-1 for dry internal conditions.
- b) Stainless steel A2 or A4-50, A2 or A4-70, A4-80 and HCR class 70 and 80 for structures subject to external atmospheric exposure (including industrial and marine environment) and to permanently damp internal condition.

Nuts and washers:

Corresponding to anchor rod material above mentioned for the different environmental exposures.

Installation:

- Category w/w: installation in to dry or wet environmental conditions.
- Perforation with drilling machine

Proposed design methods:

- Static and quasi-static load: EOTA TR 054, Design Method A.

AT-HP / AT-HP PLUS / S&P ResAC-19	Annex B1 of European Technical Assessment ETA-23/0254
Intended use - Specification	

Table B1 Installation data for solid masonry (brick n°1)*

Size		M6	M8	M10	M12
Nominal drilling diameter	d_0 [mm]	8	10	12	14
Maximum diameter hole in the fixture	d_{fix} [mm]	7	9	12	14
Embedment depth	h_{ef} [mm]	80	80	85	85
Depth of the drilling hole	h_1 [mm]	$h_{ef} + 5$ mm			
Torque moment	T_{inst} [Nm]	1	1	1	1
Thickness to be fixed	$t_{fix,min}$ [mm]	> 0			
	$t_{fix,max}$ [mm]	< 1500			
Minimum spacing	S_{min} [mm]	240	240	255	255
Minimum edge distance	C_{min} [mm]	120	120	127.5	127.5

* Type of bricks are detailed in the Annex B9

Table B2: Installation data for hollow/perforated masonry (brick n° 2)*

Size		M6	M8	M10	M12
Plastic sleeve		12 x 80		16 x 85	
Nominal drilling diameter	d_0 [mm]	12	12	16	16
Maximum diameter hole in the fixture	d_{fix} [mm]	7	9	12	14
Embedment depth	h_{ef} [mm]	80	80	85	85
Depth of the drilling hole	h_1 [mm]	$h_{ef} + 5$ mm			
Torque moment	T_{inst} [Nm]	2	2	2	2
Thickness to be fixed	$t_{fix,min}$ [mm]	> 0			
	$t_{fix,max}$ [mm]	< 1500			
Minimum spacing	$S_{min, }$ [mm]	250	250	250	250
	$S_{min,\perp}$ [mm]	120	120	120	120
Minimum edge distance	C_{min} [mm]	100	100	100	100

* Type of bricks are detailed in the Annex B9

AT-HP / AT-HP PLUS / S&P ResAC-19

Intended use - data

Annex B2
of European
Technical Assessment
ETA-23/0254

Manual blower pump: nominal dimensions

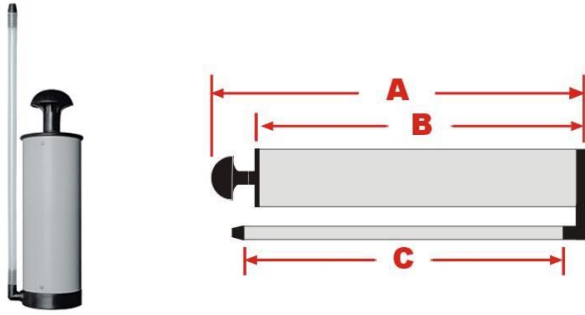

190mm (240x190x300mm) Article no. 65561	280mm (330x280x300mm) Article no. 65562	400mm (420x370x350mm) Article no. 84106
-(A) : 240mm (overall)	-(A) : 330mm (overall)	-(A) : 420mm (overall)
-(B) : 190mm (Body)	-(B) : 280mm (Body)	-(B) : 370mm (Body)
-(C) : 300mm (Tube)	-(C) : 300mm (Tube)	-(C) : 350mm (Tube)

Steel Wire Brushes

Art. No. Specification

-  **65576 18 mm**
-  **65575 13 mm**
-  **65578 10 mm**





Table B3: Brush diameter

Type of threaded rod			Use in solid masonry				Use in hollow/perforated masonry			
			M6	M8	M10	M12	M6	M8	M10	M12
d_o	Nominal drill hole	[mm]	8	10	12	14	16	16	16	16
d_b	Brush diameter	[mm]	10	10	13	13	18	18	18	18

AT-HP / AT-HP PLUS / S&P ResAC-19

Cleaning tools

Annex B3
of European
Technical Assessment
ETA-23/0254





Resin injection pump details		
Image	Size Cartridge / Code	Type
	165 / 300ml Art 65463 – 165 / 300 ml 10:1	Manual
	345 / 380 / 400 / 410 / 420ml Art 65464 - 420 ml 10:1 Art 65472 - 345 ml 10:1	Manual
	165 / 300 / 345 / 380 / 400 / 410 / 420ml Art 66399 165 / 300 ml Art 65486 345ml Art 65484 380 / 400 / 410 / 420 ml 7.4v Tool	Battery
	380 / 400 / 410 / 420 / 825ml Art 65461 380 / 400 / 410 / 420 ml Art 65462 825ml	Pneumatic

AT-HP / AT-HP PLUS / S&P ResAC-19

Tools for injection

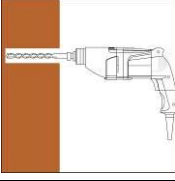
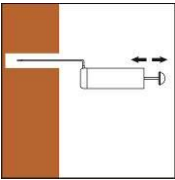
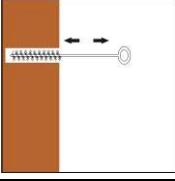
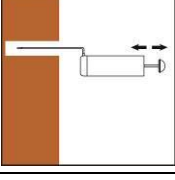
Annex B4
of European
Technical Assessment
ETA-23/0254

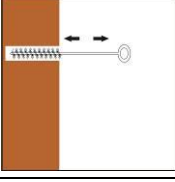
Table B4 - parameters: drilling, hole cleaning and installation in solid brick work

Instructions for use		
Bore hole drilling		
		Drill hole to the required embedment depth with a hammer drill set in rotation-hammer mode using an appropriately sized carbide drill bit.
Bore hole cleaning Just before setting an anchor, the bore hole must be free of dust and debris.		
a) Manual air cleaning (MAC)		
	X 4	The manual pump may be used for blowing out bore holes Blow out at least 4 times from the back of the bore hole until return air stream is free of noticeable dust.
	X 4	Brush 4 times with the specified brush size (brush $\varnothing \geq$ bore hole \varnothing , see Table B3) by inserting the steel brush to the back of the hole (if needed with an extension) in a twisting motion and removing it. The brush must produce natural resistance as it enters the bore hole. If not, the brush is too small and must be replaced with the proper brush diameter.
	X 4	Blow out again with manual pump at least 4 times until return air stream is free from noticeable dust.
b) Compressed air cleaning (CAC)		
	X 2	Blow 2 times from the back of the hole (if needed with a nozzle extension) over the hole length with oil-free compressed air (min. 6 bar at 6m ³ /h) until return air stream is free from noticeable dust.
	X 2	Brush 2 times with the specified brush size (brush $\varnothing \geq$ bore hole \varnothing , see Table B3) by inserting the steel brush to the back of the hole (if needed with an extension) in a twisting motion and removing it. The brush must produce natural resistance as it enters the bore hole. If not, the brush is too small and must be replaced with the proper brush diameter.
	X 2	Blow out again with compressed air at least 2 times until return air stream is free from noticeable dust.
AT-HP / AT-HP PLUS / S&P ResAC-19		Annex B5 of European Technical Assessment ETA-23/0254
Procedure for solid masonry (1)		



Instructions for use	
	Remove the threaded cap from the cartridge. Cut open the foil bag below the clip if necessary
	Tightly attach the mixing nozzle. Do not modify the mixer in any way. Make sure the mixing element is inside the mixer. Use only the supplied mixer.
	Insert the cartridge into the BIT dispenser gun.
	Discard the initial trigger pulls of adhesive. Depending on the size of the cartridge, an initial amount of adhesive mix must be discarded. Discard quantities are – 10cm for all cartridges
Instructions for use	
	Insert the nozzle to the bottom of the hole and inject the resin until the hole is filled 75%
	Insert the anchor, slowly with a slight twisting motion into the hole. Remove excess resin and leave the fixing until minimum curing (loading) times has elapsed
AT-HP / AT-HP PLUS / S&P ResAC-19	Annex B6 of European Technical Assessment ETA-23/0254
Procedure for solid masonry (2)	

Table B5 - parameters: drilling, hole cleaning and installation in hollow brick work

Instructions for use		
Bore hole drilling		
		Drill hole to the required embedment depth with a hammer drill set in rotation-hammer mode using an appropriately sized carbide drill bit.
Bore hole cleaning Just before setting an anchor, the bore hole must be free of dust and debris.		
a) Manual air cleaning (MAC)		
	X 4	The manual pump may be used for blowing out bore holes Blow out at least 4 times from the back of the bore hole until return air stream is free of noticeable dust.
	X 4	Brush 4 times with the specified brush size (brush $\varnothing \geq$ bore hole \varnothing , see Table) by inserting the steel brush to the back of the hole (if needed with an extension) in a twisting motion and removing it. The brush must produce natural resistance as it enters the bore hole. If not, the brush is too small and must be replaced with the proper brush diameter.
	X 4	Blow out again with manual pump at least 4 times until return air stream is free from noticeable dust.
b) Compressed air cleaning (CAC)		
	X 2	Blow 2 times from the back of the hole (if needed with a nozzle extension) over the hole length with oil-free compressed air (min. 6 bar at 6m ³ /h) until return air stream is free from noticeable dust.
	X 2	Brush 2 times with the specified brush size (brush $\varnothing \geq$ bore hole \varnothing , see Table B3) by inserting the steel brush to the back of the hole (if needed with an extension) in a twisting motion and removing it. The brush must produce natural resistance as it enters the bore hole. If not, the brush is too small and must be replaced with the proper brush diameter.
	X 2	Blow out again with compressed air at least 2 times until return air stream is free from noticeable dust.
AT-HP / AT-HP PLUS / S&P ResAC-19		Annex B7 of European Technical Assessment ETA-23/0254
Procedure for hollow/perforated masonry (1)		

Instructions for use	
	Remove the threaded cap from the cartridge without cutting. Cut open the foil bag below the clip if necessary.
	Tightly attach the mixing nozzle. Do not modify the mixer in any way. Make sure the mixing element is inside the mixer. Use only the supplied mixer with the adhesive.
	Insert the cartridge into the dispenser. Press the release trigger to retract the plunger and insert the cartridge neatly into the cradle without any distortion.
	Discard the initial trigger pulls 10cm of adhesive. Resin will flow from the cartridge as soon as dispensing is initiated.

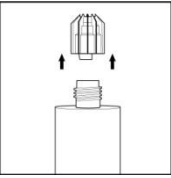
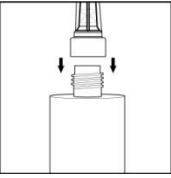
Instructions for use	
	Introduce the sleeve of suitable dimension (see table) to the back of the hole so that the collar is level with the hole face. The cap may be opened to allow full nozzle insertion.
	Insert the nozzle to the end of the sleeve and inject the resin until the sleeve is 100% filled. Close the cap.
	Insert the anchor, slowly with a slight twisting motion into the sleeve. Remove excess resin and leave the fixing until minimum curing (loading) times has elapsed

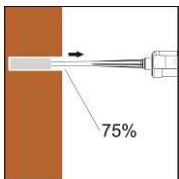
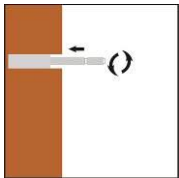
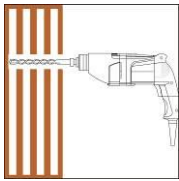
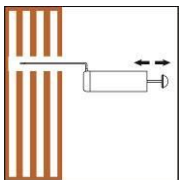
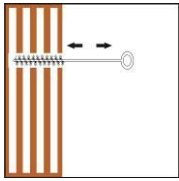
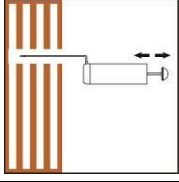
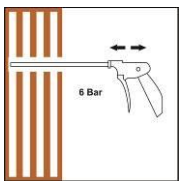
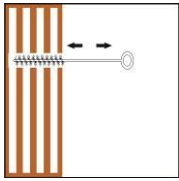
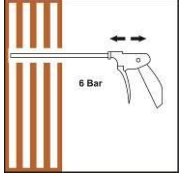
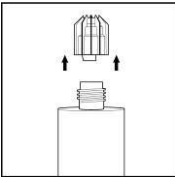
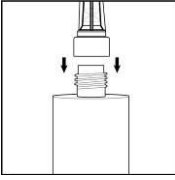
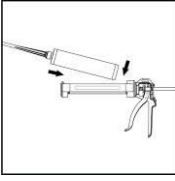
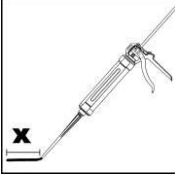
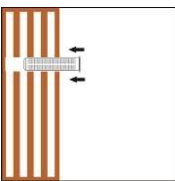
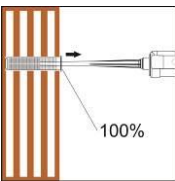
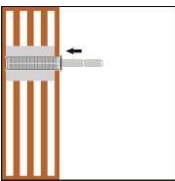
AT-HP / AT-HP PLUS / S&P ResAC-19

Procedure for hollow/perforated masonry (2)

Annex B8
of European
Technical Assessment
ETA-23/0254

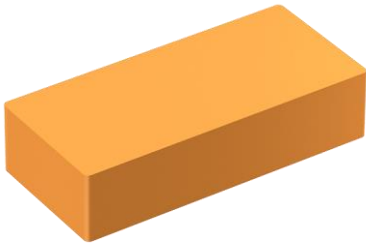

Category b: Solid clay masonry:

Mattone pieno UNI (12.6.25)

Bulk density class $\rho=1.6 \text{ kg/dm}^3$

Minimum compressive strength $f_b=18 \text{ MPa}$

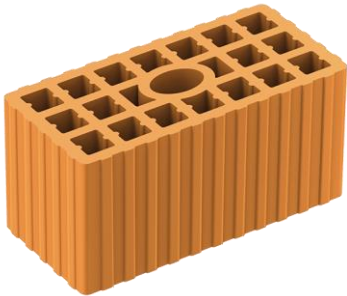

Category c: Hollow masonry:

Doppio UNI (12.12.25)

Bulk density class $\rho=0.9 \text{ kg/dm}^3$

Minimum compressive strength $f_b=6.0 \text{ MPa}$

AT-HP / AT-HP PLUS / S&P ResAC-19

Type and dimensions of brick

Annex B9
of European
Technical Assessment
ETA-23/0254

Table C1: Design method A, characteristic tension and shear load values

ESSENTIAL CHARACTERISTICS			PERFORMANCE			
Installation parameters			M6	M8	M10	M12
d	[mm]		6	8	10	12
d ₀ category b (solid masonry)	[mm]		8	10	12	14
d ₀ category c (hollow or perforated masonry)	[mm]		12	12	16	16
Type of plastic sleeve for use in category c			12x80	12x80	16x85	16x85
d _{fix}	[mm]		7	9	12	14
h ₁	[mm]		h _{ef} + 5 mm			
t _{fix}	Min	[mm]	> 0			
	Max	[mm]	≤ 1500 mm			
T _{inst} category b (solid masonry)	[Nm]		1	1	1	1
T _{inst} category c (hollow or perforated masonry)	[Nm]		2	2	2	2
S _{min} category b (solid masonry)	[mm]		240	240	255	255
C _{min} category b (solid masonry)	[mm]		120	120	127.5	127.5
S _{min} category c (hollow masonry) S _{min,}	[mm]		250	250	250	250
S _{min} category c (hollow) S _{min,⊥}	[mm]		120	120	120	120
C _{min} category c (hollow masonry)	[mm]		100	100	100	100
* Resistance for tensile and shear load			M6	M8	M10	M12
Temperature range -40°C/+40°C (T_{mip} = 24°C)						
Brick n°1 (solid)	N _{Rk}	[kN]	4	4	5	5
	V _{Rk}	[kN]	2	2	6	6
Brick n°2 (hollow)	N _{Rk}	[kN]	0,75	0,75	1,5	1,5
	V _{Rk}	[kN]	1,5	1,5	1,5	1,5

Table C2: Characteristic bending moments

Size			M6	M8	M10	M12
Characteristic resistance with standard threaded rod grade 4.6	M _{Rk,s}	[Nm]	6	15	30	52
Partial safety factor	γ _{Ms}	[-]	1,67			
Characteristic resistance with standard threaded rod grade 5.8	M _{Rk,s}	[Nm]	8	19	37	66
Partial safety factor	γ _{Ms}	[-]	1,25			
Characteristic resistance with standard threaded rod grade 8.8	M _{Rk,s}	[Nm]	12	30	60	105
Characteristic resistance with standard threaded rod grade 10.9	M _{Rk,s}	[Nm]	15	37	75	131
Partial safety factor	γ _{Ms}	[-]	1,25			
Characteristic resistance with standard threaded rod stainless steel A2, A4-70 and HCR (class 70)	M _{Rk,s}	[Nm]	11	26	52	92
Partial safety factor	γ _{Ms}	[-]	1,56			
Characteristic resistance with standard threaded rod stainless steel A4-80 and HCR (class 80)	M _{Rk,s}	[Nm]	12	30	60	105
Partial safety factor	γ _{Ms}	[-]	1,33			

AT-HP / AT-HP PLUS / S&P ResAC-19

Performance for static and quasi-static loads: Resistances

Annex C1
of European
Technical Assessment
ETA-23/0254

Table C3: Characteristic values for tension and shear load.

ESSENTIAL CHARACTERISTICS		PERFORMANCE			
* Resistance for tensile and shear load Temperature range $-40^{\circ}\text{C}/+40^{\circ}\text{C}$ ($T_{\text{mlp}} = 24^{\circ}\text{C}$)		M6	M8	M10	M12
γ_{Mm} [-] Category w/w		2,50			
Brick n°1	$S_{\text{cr,N}}$ [mm]	240	240	255	255
	$C_{\text{cr,N}}$ [mm]	120	120	127,5	127,5
Brick n°2	$S_{\text{cr,N, }}$ [mm]	250	250	250	250
	$S_{\text{cr,N}\perp}$ [mm]	120	120	120	120
	$C_{\text{cr,N}}$ [mm]	100	100	100	100
β coefficient for in situ test (ETAG 029 Annex B) Temperature range: $-40^{\circ}\text{C}/+40^{\circ}\text{C}$		M6	M8	M10	M12
Brick N° 1 - Solid brick	β [-]	0,64	0,64	0,66	0,66
Brick N° 2 - Hollow/perforated brick	β [-]	0,64	0,64	0,66	0,66
Displacement under service load					
Tensile load					
Temperature range $-40^{\circ}\text{C}/+40^{\circ}\text{C}$ ($T_{\text{mlp}} = 24^{\circ}\text{C}$)					
Brick n°1 – Solid brick		M6	M8	M10	M12
Admissible service load in tensile	F [kN]	1,14		1,43	
Displacement	δ_{N0} [mm]	0,14	0,14	0,07	0,05
	$\delta_{\text{N}\infty}$ [mm]	0,28	0,28	0,13	0,09
Brick n°2 – Hollow/perforated brick		M6	M8	M10	M12
		With sleeve	With sleeve	With sleeve	With sleeve
Admissible service load in tensile	F [kN]	0,21		0,43	
Displacement	δ_{N0} [mm]	0,07	0,07	0,16	0,11
	$\delta_{\text{N}\infty}$ [mm]	0,13	0,13	0,31	0,22

AT-HP / AT-HP PLUS / S&P ResAC-19

Performance for static, quasi-static: Displacements

Annex C2
of European
Technical Assessment
ETA-23/0254

Table C3 cont.: Characteristic values for tension and shear load.

ESSENTIAL CHARACTERISTICS		PERFORMANCE			
Displacement under service load					
Shear load					
Temperature range -40°C/+40°C (T_{mlp} = 24°C)					
Brick n°1 – Solid brick		M6	M8	M10	M12
Admissible service load in shear	F [kN]	0,57		1,71	
Displacement	δ _{v0} [mm]	0,15	0,15	0,26	0,27
	δ _{v∞} [mm]	0,22	0,22	0,39	0,41
Brick n°2 – Hollow/perforated brick		M6 With sleeve	M8 With sleeve	M10 With sleeve	M12 With sleeve
Admissible service load in shear	F [kN]	0,43			
Displacement	δ _{v0} [mm]	1,01	1,01	0,5	0,36
	δ _{v∞} [mm]	1,52	1,52	0,74	0,54

Table C4: Reaction to fire.

ESSENTIAL CHARACTERISTICS	PERFORMANCE
Reaction to fire	In the final application the thickness of the mortar layer is about 1 to 2 mm and most of the mortar is material classified class A1 according to EC Decision 96/603/EC. Therefore, it may be assumed that the bonding material (synthetic mortar or a mixture of synthetic mortar and cementitious mortar) in connection with the metal anchor in the end use application do not make any contribution to fire growth or to the fully developed fire and they have no influence to the smoke hazard.

Table C5: Resistance to fire.

ESSENTIAL CHARACTERISTICS	PERFORMANCE
Resistance to fire	NPA

AT-HP / AT-HP PLUS / S&P ResAC-19

Performance for static, quasi-static and seismic loads: Displacements

Annex C3
of European
Technical Assessment
ETA-23/0254